

Multilin N60



Synchrophasors, Load Shedding, Remedial Action, Special Protection Schemes

The Multilin™ N60 network stability and synchrophasor measurement system is a flexible device intended for the development of load shedding, remedial action, special protection schemes and wide area monitoring and control.

Special protection schemes are unique to each installation and are carefully matched to a given system topology, operating practices and system protection philosophies of a given utility. The N60 provides an exceptionally flexible platform to easily integrate and facilitate the specific special protection schemes needed for a wide range of applications.

Key Benefits

- Scalable synchrophasor measurements with up to 6 PMUs per relay reducing synchrophasor cost by up to 80%
- Real-time access to remote analog data, providing for advanced wide area applications and enhanced system security
- Exceeds latest IEEE® C37.118 (2011) standard for PMU measurement devices with a TVE of less than 1%, protection and metering class synchrophasors and multi-cast IEC® 61850-90-5 support
- Uninterrupted synchrophasor measurements during fault and disturbances, providing highly reliable capture of data for critical control functions and post-mortem analysis
- Simplified system integration with direct connection to JungleMUX SONET, TN1U SDH and TN1Ue SDH networks
- Advanced IEC 61850 Ed. 1 and Ed. 2 certified implementation, complete settings via SCL files and comprehensive process bus support (IEC 61850-9-2LE or IEC 61869 or IEC 61850-9-2 Hardfiber) ensures interoperability, device managing optimization and reduced cost of ownership
- Routable GOOSE (R-GOOSE) enables customer to send GOOSE messages beyond the substation, which enables WAPC and more cost effective communication architectures for wide area applications
- Increased network availability via failover time reduced to zero through IEC 62439-3 "PRP" support
- Supports IEEE C37.111-1999/2013, IEC 60255-24 Ed 2.0 COMTRADE standard
- Multi-range Signal Oscillation Detector (MSOD)

Applications

- Decrease blackouts by identifying network instabilities and taking fast preventative action
- Increase utilization of existing investments by identifying power transfer capability on existing lines
- Facilitate contingency planning through continuous synchrophasor data collection and postmortem analysis
- Provides enhanced state estimation for SCADA to optimize system-wide load shedding and remedial action schemes
- Forced Oscillations (NERC), frequency, magnitude, phase and damping Oscillation detection

Protection & Control

- Under/over frequency, df/dt, under/over voltage and synchrocheck
- Three phase undervoltage and one phase overvoltage elements
- FlexMath for automated network control enabling automatic load shedding, power balancing and remedial action schemes
- High density inputs/outputs to support the control of many switchyard assets – all from one powerful device
- Integrated large, full color display, for real-time visualization and control of the protected bay

Advanced Communications

- Synchrophasor streaming over Ethernet, up to four PDCs simultaneously, reporting rates from 1 to 120 phasors/sec
- 3 independent Ethernet ports for simultaneous & dedicated network connections with IEEE 1588 support
- N60-to-N60 communications using direct fiber or through multiplexers using G.703, RS422, or C37.94 interfaces
- IEC 61850-9-2LE/IEC 61869 networked or IEC61850-9-2 Hardfiber process bus support

Cyber Security

- CyberSentry™ provides high-end cyber security aligned to industry standards and services (NERC® CIP, AAA, Radius, RBAC, Syslog)

Monitoring & Metering

- Synchrophasor recording: 12MB of memory with multiple recording and triggering options, 46 configurable channels
- Advanced recording capabilities with high-capacity event recorder, configurable and extended waveform capture and data logger
- Metering: current, voltage, power, energy, frequency, and harmonics
- Embedded multi-range signal oscillation detection (MSOD)



Overview

As part of the UR family of Protection & Control devices, the Multilin N60 Network Stability and Security System offers a high degree of modularity in its design and functionality, providing superior performance while meeting the toughest requirements of the marketplace. As an advanced Synchrophasor Measurement device, the N60 supports wide area monitoring and other grid modernization applications through the following:

Synchrophasors

The N60 is also a source of synchronized phasor measurements known as synchrophasors. The N60 meets all and exceeds many of the requirements of the IEEE C37.118 synchrophasors for power systems standard. The N60 can simultaneously stream P and M class synchrophasors over its Ethernet ports at configurable discrete rates of 1 to 120 frames per second. In addition to streaming synchrophasors, the N60 can be controlled through programmable triggers to store snapshot records of synchrophasor data in the 12MB of onboard memory.

Peer-to-Peer Communications

The N60 provides two distinct methods, direct I/O and IEC 61850 GOOSE, for sharing information about the state of a local station to other local or remote N60's. Using direct I/O messaging, the N60's can share real-time analog information and local control decisions with other remote sites to facilitate a desired control action. In addition, local control commands can be sent to other IEDs via the IEC 61850 GOOSE

N60 - Protection, Metering, Monitoring and Control

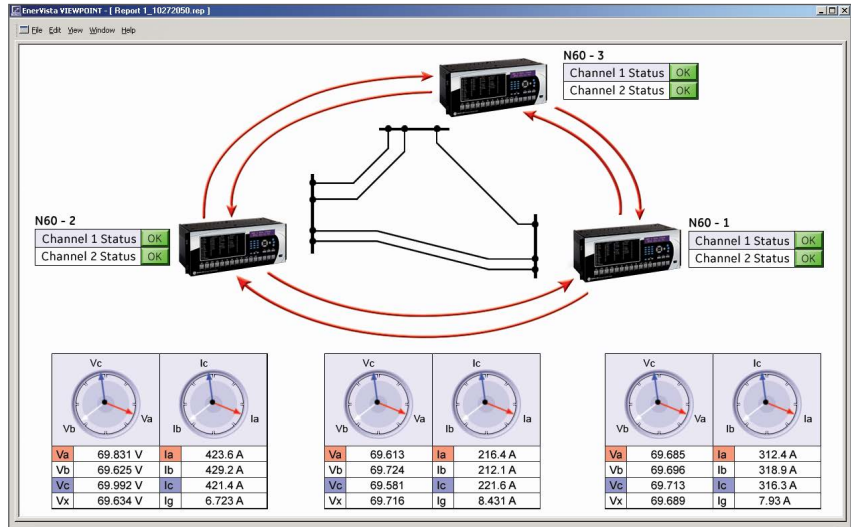

The N60 is the single point for protection, control, metering, and monitoring in one integrated device that can easily be connected directly into DCS or SCADA monitoring and control systems like Viewpoint Monitoring as shown.

mechanisms where digital point-to-point messaging can be achieved in 4ms. Further operational sophistication can be achieved by using the analog GOOSE capability to transfer analog values between local devices.

Special Protection Schemes

The advanced local and remote communications ability of the N60, along with its superior automation control functions, provide a flexible platform for addressing a broad range of network stability applications including:

- Controlled openings of interconnections
- Controlled islanding of the local system
- Load shedding
- Fast-valving
- Tripping of generators
- Fast dispatch of generation
- HVDC power control adjustments
- Series capacitor Automatic Voltage Regulator (AVR) setpoint and tap change control
- Multi-range Signal Oscillation Detector (MSOD)

Functional One-Line Diagram

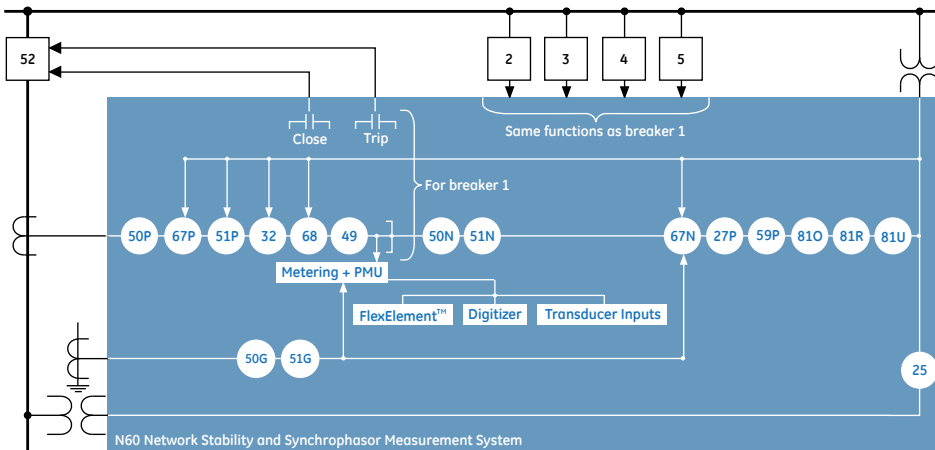

The N60 can monitor and control up to 5 power system circuits.

ANSI® Device Numbers & Functions

DEVICE NUMBER	FUNCTION
25	Synchrocheck
27P	Phase undervoltage
32	Sensitive directional power
49	Thermal overload protection
50DD	Disturbance detector
50G	Ground instantaneous overcurrent
50N	Neutral instantaneous overcurrent
50P	Phase instantaneous overcurrent
51G	Ground time overcurrent
51N	Neutral time overcurrent
51P	Phase time overcurrent
59P	Phase overvoltage
67N	Neutral directional overcurrent
67P	Phase directional overcurrent
68	Power swing blocking
81O	Overfrequency
81R	Rate of change frequency
81U	Underfrequency
	Harmonic/Inrush detectio

Truly Distributed Architecture

Sophisticated special protection schemes can be developed exclusively using N60 devices without any other central controllers. The N60 can be configured to make smart decisions based on real-time information that it has received from N60's located across a large geographic area. The N60 has built-in abilities to detect the failure of communications to other devices, which allows for the configuration of the devices to self-adjust or adapt its decisions based on the information that is available to it.

Monitor Multiple Power Circuits

The N60 can monitor from one up to six three-phase power circuits and can be configured to simultaneously provide as many as 6 PMUs. The N60 provides metering of many power system quantities including active, reactive and apparent power on a per-phase, and three-phase basis, true RMS value, phasors and symmetrical components of currents and voltages, power factor, and frequency. Frequency can be measured independently and simultaneously from up to six different signals, including currents if needed. The N60 allows for creating and processing virtual sums of currents through its user configuration mechanism of "signal sources".

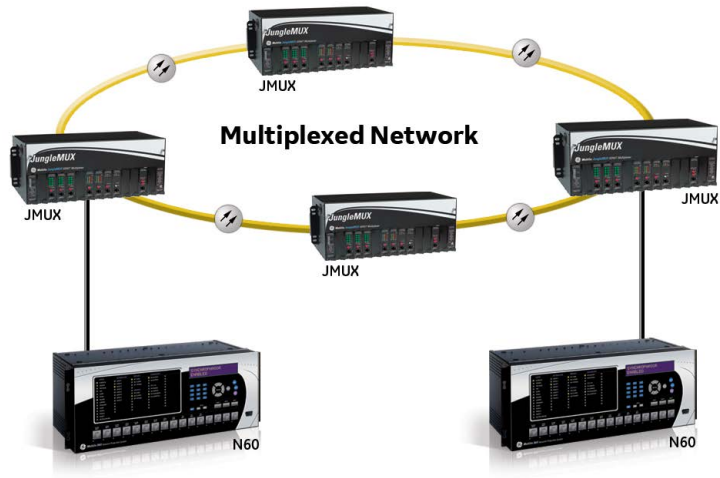

N60's can be directly connected to multiplexed networks using a variety of different interfaces to communicate with other N60's spread out across the transmission network.

IEC 61869 and 61850-9-2LE Process Bus

Three UR process bus modules enable communicating to Merging Units "MU" that comply to either IEC 61869 standard or IEC 61850-9-2LE technical report. MUs connect to the primary asset and translate analog signals and digital status/commands to standard sample values "SV" data and GOOSE messages.

Flexibility for connecting to different network size and topology is granted through 100Mbps and/or 1Gbps Ethernet port support, plus IEC 62439 PRP

or HSR standard redundancy, plus Star, Ring and Point-to-point network support.

For time synchronization purposes, this Process bus module can become an IEEE 1588 slave clock (61850-9-3 profile) or a 1588 Grand Master clock which removes the need of external time sources connected to the process bus network.

Customers who may not be using GE MU devices, could use MU from other vendors. Interoperability with MU from other vendors is expected when they comply to the mentioned standards.

Figure 1

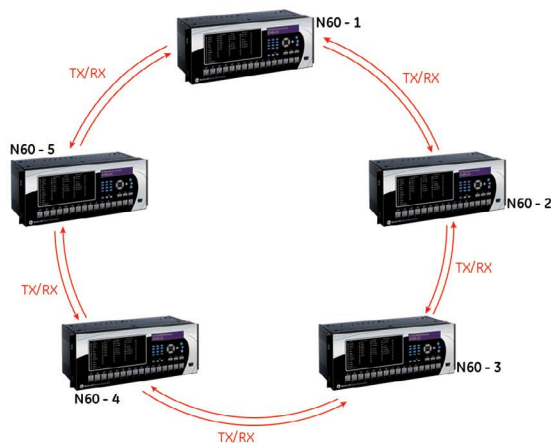
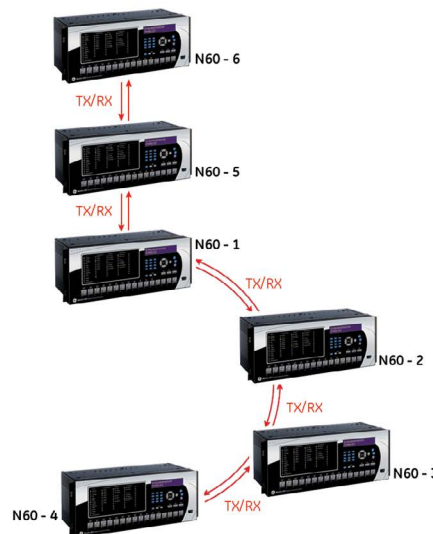

Figure 2



N60's can be directly connected to other N60's in a ring configuration, providing network redundancy as seen in Figure 1, or an open ring configuration to span long distances, as seen in Figure 2.

Topologies:

PRP Star
Hot-Standby

Topologies:

HSR Ring
PRP Star
P-2-P Process Bus

Merging units

Conventional or Optical CT/VTs

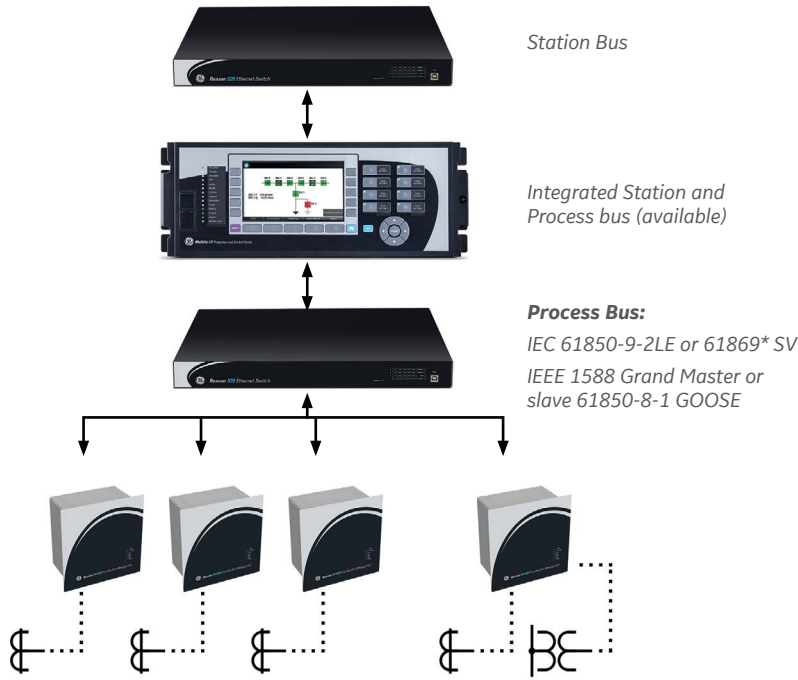

Inter-Relay Communications

The N60 has very advanced communications capabilities in the protection and control industry, for sharing information about the power system with other local or remote devices. Using direct peer-to-peer communications for sharing information with other N60's distributed across the network, and using the many available SCADA protocols, the N60 can provide the complete solution for carrying out special protection schemes and SCADA monitoring and control functions.

Direct I/O and Direct Analog

The direct I/O and direct analog features allow for the sharing of both digital and analog information with up to 16 other N60 devices connected directly through fault tolerant fiber optic ring networks or through a multiplexed communications network. The N60 supports dual channel communications where each channel can support a different physical connection, providing the ability to connect to completely segregated networks and allow for truly redundant inter-substation communication architectures. The communications interfaces available include direct fiber optics (up to 100km), G.703, and RS422 interfaces and is fully compatible with Multilin's JMUX SONET, TN1U SDH and TN1Ue SDH multiplexers.

Direct I/O

Using the direct I/O, each N60 can send the status of up to 64 ON/OFF digital states to other N60's spread across the network. The message delivery from one N60 to another varies with the number of other N60's located between the sending and receiving devices, but delivery times of one to two cycles is achievable for very large networks and will be repeatable and deterministic for all communications between those two devices. This high-speed sharing of information allows for N60's to obtain real-time information about the status of other parts of the network and of decisions made by other devices on the network.

Direct Analogs

Direct analogs provide the ability to share the value of analog quantities measured by the local N60 with other N60's distributed across the network. This analog data is transmitted across the network whenever the value varies beyond a preset deadband, up to a rate of every 250ms. With this information, N60's can evaluate what is happening around the rest of the network and make smart decisions about what control actions to take, as implemented for the various special protection schemes.

IEC 61850-9-2 HardFiber Process Bus

The IEC 61850 Process Bus module is designed to interface with the Multilin HardFiber System, allowing bi-directional IEC 61850 fiber optic communications. The HardFiber System is designed to integrate seamlessly with existing Universal Relay (UR) applications, including protection functions, FlexLogic™, metering and communications.

The Multilin HardFiber System offers the following benefits:

- Communicates using open standard IEC 61850 messaging
- Drastically reduces P&C design, installation and testing labor by eliminating individual copper terminations
- Integrates with existing N60's by replacing traditional CT/VT inputs with the IEC 61850 Process Bus module
- Does not introduce new cyber security concerns

Visit the HardFiber System product page on the GE Grid Solutions web site for more details.

Cyber Security – CyberSentry UR

CyberSentry™ is a software option that delivers wide range of cyber security features that help customers to comply with NERC CIP, NIST® IR 7628, IEC 62351 and IEC 62443 cyber security requirements and standards. Additionally secure

FW upgrade is granted through UR Setup's digital signature validation capabilities. This software option delivers the following core features:

AAA Server Support (Radius/LDAP)

Enables integration with centrally managed authentication and accounting of all user activities and uses modern industry best practices and standards that meet and exceed NERC CIP requirements for authentication and password management.

Role Based Access Control (RBAC)

Efficiently administrate users and roles within UR devices. The new and advanced access functions allow users to configure up to five roles for up to eight configurable users with independent passwords. The standard "Remote Authentication Dial In User Service" (Radius) is used for authentication.

Event Recorder (Syslog for SEM)

Capture all cyber security related events within a SOE element (login, logout, invalid password attempts, remote/local access, user in session, settings change, FW update, etc), and then serve and classify data by security level using standard Syslog data format. This will enable integration with established SEM (Security Event Management) systems.

Network Communications Diagnostics

The N60 direct I/O and direct analogs incorporate sophisticated self-monitoring and diagnostic functions that can be monitored and evaluated to identify problems with the integrity of the communications network. Included in these diagnostics features are a 32-bit CRC, an unreturned messages count, and a count of the total number of lost packets.

Communications

The N60 embraces the most advanced communication technologies available today for remote data and engineering access that provide an easy method of integrating information from around a network into new or existing infrastructures. Direct support for redundant fiber optic Ethernet provides high-bandwidth communications allowing for low-latency controls and high-speed file transfer of synchrophasor and event recording information transfers in a cost-effective fault tolerant network.

The N60 supports the most popular industry standard communications protocols enabling easy, direct integration into SCADA systems.

- IEC 61850 Ed. 1 and Ed. 2 Station Bus, IEC 61850-2-2LE / IEC 61869 networked or IEC 61850-9-2 HardFiber Process Bus, and IEC 61850-90-5 PMU over GOOSE support
- DNP 3.0 (serial & TCP/IP)
- Ethernet Global Data (EGD)
- IEC 60870-5-103 and IEC 60870-5-104
- Modbus RTU, Modbus TCP/IP
- HTTP, TFTP, SFTP and MMS file transfer
- IEEE 1588 and redundant SNTP for time synchronization
- PRP as per IEC 62439-3
- IEC61850 GOOSE, Routable GOOSE and legacy UCA fixed GOOSE

Interoperability with Embedded IEC 61850 Ed. 1 and Ed. 2

The new IEC 61850 implementation in the UR Family positions GE as an industry leader in this standard.

- Implements, user selectable, Ed. 1 and Ed. 2 of the standard across the entire UR Family
- Provides full relay setting management via standard SCL files (ICD, CID and IID)
- Enables automated relay setting management using 3rd party tools through standard file transfer services (MMS and SFTP)

- Increases the number of Logical Devices and data mapped to them, GOOSE messages from up to 64 remote devices, and reports to support different organizational needs for data transfer and reduce dependency on generic logical nodes
- Configures GE Systems based on IEC 61850 using universal 3rd party tools
- Multicast IEEE C37.118 synchrophasor data between PMU and PDC devices using IEC 91850-90-5
- R-GOOSE enable customer to send GOOSE messages beyond the substation, which enables WAPC and more cost effective communication architectures for wide area applications

LAN Redundancy

Substation LAN redundancy has been traditionally accomplished by reconfiguring the active network topology in case of failure. Regardless of the type of LAN architecture (tree, mesh, etc), reconfiguring the active LAN requires time to switchover, during which the LAN is unavailable. UR devices deliver redundancy as specified by PRP-IEC 62439-3, which eliminates the dependency on LAN reconfiguration and the associated switchover time. The UR becomes a dual attached node that transmits data packets over both main and redundant networks simultaneously, so in case of failure, one of the data packets will reach the receiving device with no time delay.

Multi-Language

UR devices support multiple languages: English, French, Russian, Chinese, Turkish and German. These language options are available on the front panel, in the EnerVista setup software, and in the product manuals. Easily switch between English and an additional language on the local displays without uploading new firmware.

Protection and Control

The N60 incorporates a wide range of protection and control functions that are typically required for special protection schemes. These protection and control elements along with the use of the advanced FlexLogic, FlexMath, and FlexElements, allow for the creation of automated system controls for customized special protection schemes.

Abnormal Frequency Protection

Detecting changes in the frequency at a particular location and relaying that information to other N60's deployed across the network can

allow for creating customized schemes such as shedding some load or islanding parts of the system to counter the effect of impending system problems. Frequency elements include underfrequency, overfrequency, and rate of change of frequency.

Power Swing/Out-of-Step

The power swing blocking element provides the blocking of protection elements under power swing conditions. Negative sequence current supervisors provide extended selectivity for detecting evolving faults that may appear as a power swing event (faults with slow moving impedance locus). Additionally, the out-of-step tripping element can be used for tripping the generator when an unstable power swing is detected.

Directional Power

Two separate directional power elements are provided to detect reverse power and low forward power to interconnections that involve co-generation. Each element can be used to provide both alarming and tripping upon the detection of undesired power flow conditions.

Harmonic/Inrush detection

The Harmonic detection element monitors the selected 2nd to 5th harmonic or Total Harmonics Distortion (THD), which is present in the phase currents. The relay provides six identical Harmonic Detection elements.

During transformer energization or motor starts, the inrush current present in phase currents can impact some sensitive elements, such as negative sequence overcurrent. Therefore, the ratio of the second harmonic to the fundamental magnitude per phase is monitored, while exceeding the settable pickup level, an operand is asserted, which can be used to block such sensitive elements.

Synchrocheck

The N60 provides ten synchrocheck elements that monitor voltage difference, phase angle difference and slip frequency taking the CB closing time into account to ensure proper breaker closure as per user requirements. Any of the ten synchrocheck elements can be dynamically blocked or unblocked by other elements or user logic.

Advanced Automation

FlexLogic

FlexLogic is the powerful UR-platform programming logic engine that provides the ability to create customized protection and control schemes based on information measured locally by the N60 and received from remote N60's sent to it over the communications network. With 1024 lines of FlexLogic, the N60 can use the status of measured inputs, along with the output of the protection elements, FlexElements and FlexMath summators, in Boolean logic equations to perform automated functions for customized special protection schemes.

FlexMath

FlexMath uses a summator function to analyze and compare analog information that has been measured locally by the N60 and analog information that has been sent to it from remote N60's. Using summators, the N60 can identify differences in power quantities measured across the network and be configured to make smart decisions on this information, such as, what breakers to automatically close to restore power to non-energized parts of the system. Each FlexMath equation is executed every power system cycle, which allows the N60 to react in real-time to changing power system events.

FlexElements

FlexElements can be used to create user-defined protection elements that are based on analog parameters measured by the N60, including currents, voltages, power, frequency and power factor. Each FlexElement will analyze the programmed analog parameter for absolute changes in the input, the rate of change of the input, or by comparing the difference between two measured inputs.

Scalable Hardware

The N60 is available with a multitude of I/O configurations to suit the most demanding application needs. Each N60 can be configured to monitor up to 6 power system circuits, and when connected to other N60's using inter-IED communications modules, can create a distributed logic scheme with each N60 measuring and protecting a particular portion of the system.

- Multiple CT/VT configurations allow for measuring inputs from up to 6 power system circuits
- Types of digital outputs include trip-rated Form-A and Solid State Relay (SSR) mechanically latching, and Form-C outputs

- RTDs and DCmA inputs are available to monitor equipment parameters such as temperature and pressure

Monitoring and Metering

The N60 includes high accuracy metering and recording for all AC signals. Voltage, current, and power metering are built into the relay as a standard feature. Current and voltage parameters are available as total RMS magnitude, and as fundamental frequency magnitude and angle.

Synchrophasors

With the ability of having up to 6 PMU elements in one device, the N60 permits accurate measurement of synchrophasors over an extremely wide frequency range. The N60 exceeds the IEEE C37.118 requirements for Total Vector Error (TVE) less than 1% over a range of 40Hz to 70Hz. Additionally, the N60 can measure and report synchrophasors over a frequency range from 30Hz to 90Hz with little effect on TVE and the new P & M class synchrophasor. A special feature of the N60 synchrophasor implementation is the ability to apply magnitude and phase angle correction on a per-phase basis for known CT and PT magnitude and phase errors. The N60 can apply magnitude correction of up to +/- 5% and phase correction of up to +/- 5 degrees, both of which can be applied to each phase. The N60 also provides the ability to adjust for delta-wye phase angle shifts or polarity reversal in the synchrophasor reporting of the sequence of voltages and currents.

Synchrophasor Records

The N60 has the ability to record files of synchrophasor-measured data when instructed to, by user-configurable digital and analog triggers. The storing of synchrophasor data can be programmed to record events of a pre-defined length, or have a dynamic recording length that will continue recording as long as the trigger remains either in the high state or until the internal memory of the N60 is filled. The user can select to have old synchrophasor records to be automatically overwritten when new data is available, or have them protected until later and cleared manually. Synchrophasor records can be analyzed using the COMTRADE viewer included with the EnerVista software.

Fault and Disturbance Recording

The advanced disturbance and event recording features within the N60 can significantly reduce the time needed for postmortem analysis of power system events and the creation of regulatory reports. Recording functions include:

- Sequence of Event (SOE) - 1024 time stamped events
- Oscillography
 - Supports IEEE C37.111-1999/2013, IEC 60255-24 Ed 2.0 COMTRADE standard
 - 128 digital & up to 56 analog channels
 - Events with up to 45s length

Multi-range Signal Oscillation (MSOD)

A general purpose multi-range signal oscillation detector (MSOD) meets a broad-range of application needs for detecting power system oscillation. Oscillations are always present in power systems due to the electromechanical nature of the electric grid. However, some oscillations may become poorly or negatively damped, and could lead to system instabilities, equipment damages or system blackout if such oscillations are not detected and proper remedy actions are not taken in time

With the increased presence of power electronics, growing interconnections of power grids, and increased load demand, the coupling between synchronous generators in the system becomes weaker. As a result, some oscillations can become poorly or negatively damped and can lead to system instabilities, equipment damage, or system blackout if such oscillations are not detected and action not taken. Additionally, the North American Electric Reliability Corporation (NERC) has identified a new type of oscillation, which they call Forced Oscillations, resulting from the interaction of switched devices within the grid.

The new N60's Multi-range Signal Oscillation Detector (MSOD) meet the need for power system oscillation detection and features:

- Voltage and/or current measurement for each of the four oscillation bands
- Fast oscillation detection
- High resolution measurements
- Customizable and flexible, whereby customized bands for oscillation can be selected, be they broad or narrow
- Advanced actionable measurement, including phase angle and damping ratio

EnerVista Software

The EnerVista suite is an industry-leading set of software programs that simplifies every aspect of using the N60 relay. The EnerVista suite provides all the tools to monitor the status of your system, maintain your relay, and integrate information measured by the N60 into DCS or SCADA monitoring systems. Convenient COMTRADE and SOE viewers are an integral part of the UR setup software included with every UR relay, to carry

out postmortem event analysis and ensure proper protection system operation. UR Setup also provides an export/import setting file tool which allows customer to transfer specific settings from one file to another. This tool also provides comprehensive setting file comparison. These features, together with UR single setting file, help users to simplify their setting file management experience.

EnerVista Launchpad

EnerVista Launchpad is a powerful software package that provides users with all of the setup and support tools needed for configuring and maintaining Multilin products. The setup software within Launchpad allows for the configuration of devices in real-time by communicating using

serial, Ethernet, or modem connections, or offline by creating setting files to be sent to devices at a later time. Included in Launchpad is a document archiving and management system that ensures critical documentation is up-to-date and available when needed. Documents made available include:

- Manuals
- Application Notes
- Guideform Specifications
- Brochures
- Wiring Diagrams
- FAQ's
- Service Bulletins

Viewpoint Monitoring

Viewpoint Monitoring is a simple-to-use and full-featured monitoring and data recording software package for small systems. Viewpoint Monitoring provides a complete HMI package with the following functionality:

- Plug-&-Play Device Monitoring
- System Single-Line Monitoring & Control
- Annunciator Alarm Screens
- Trending Reports
- Automatic Event Retrieval
- Automatic Waveform Retrieval

User Interface

The N60 front panel provides extensive local HMI capabilities. The local display is used for monitoring, status messaging, fault diagnosis, and device configuration. User-configurable messages that combine text with live data can be displayed when user-defined conditions are met.

A 7" color, graphic HMI is optionally available that allows users to have customizable bay diagrams with local monitoring of status, values and control functionality. The alarm annunciator panel provides the configuration of up to 96 signals (alarms and status) with full text description.

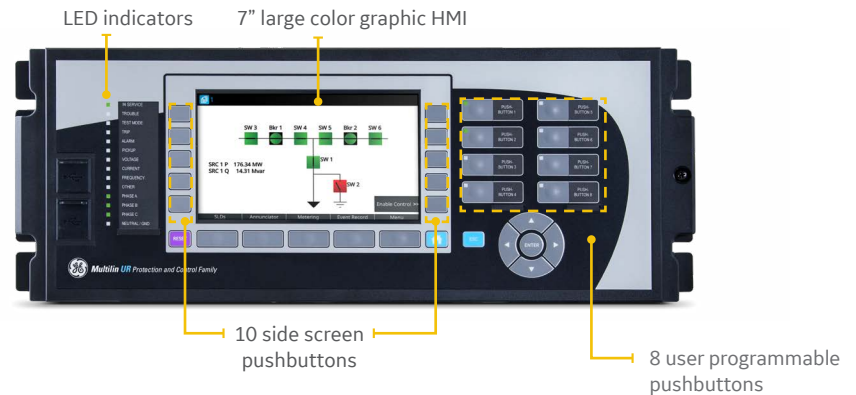

Typical Wiring

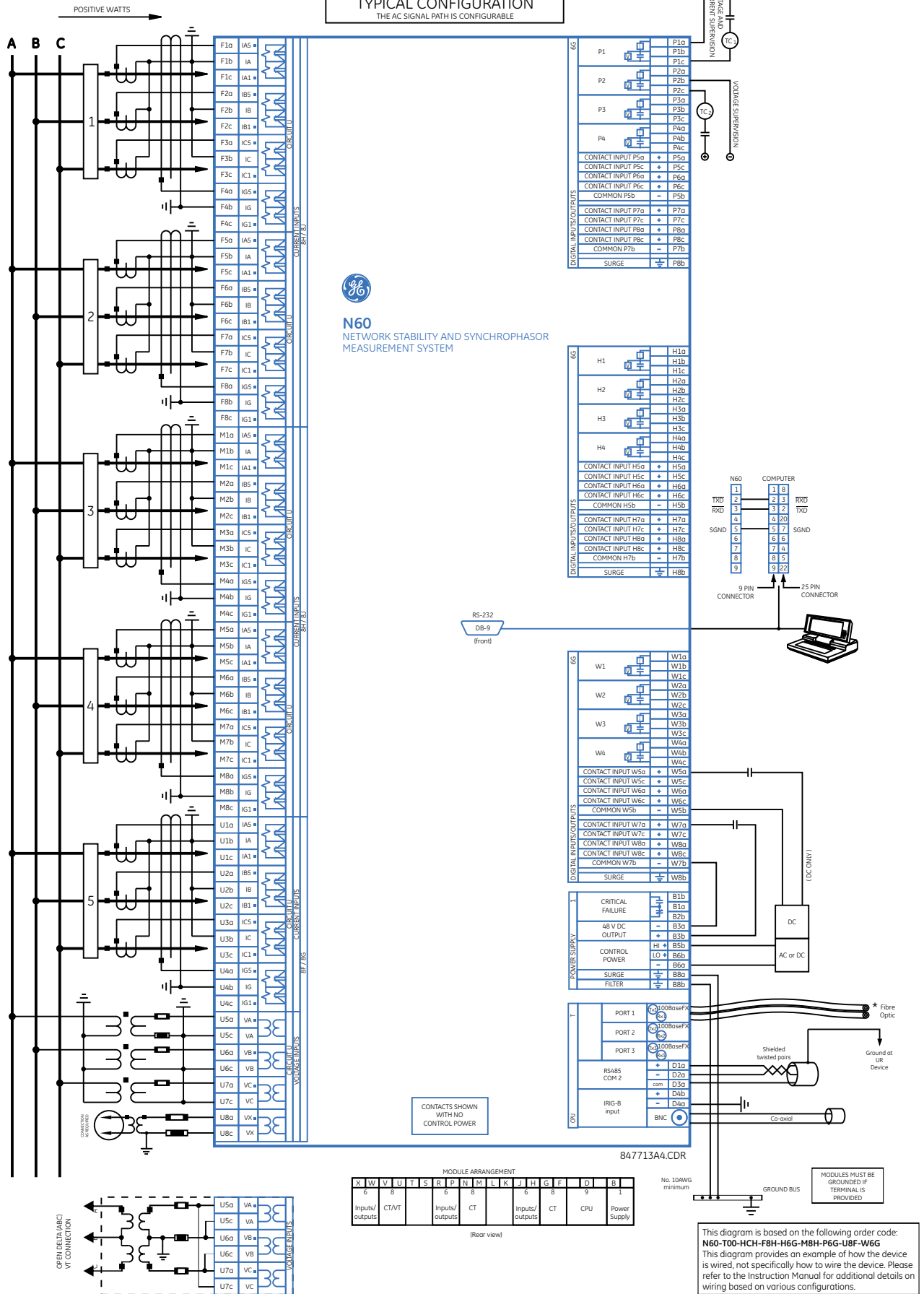

Ordering

	N60-	*	**	H	*	*	F**	H**	M**	P**	U**	W/X**	For Full Sized Horizontal Mount
Base Unit	N60												Base Unit
CPU		T	U	V	W								RS485 + three multimode SFP LC 100BaseFX RS485 + two multimode SFP LC 100BaseFX + one SFP RJ45 100BaseT RS485 + three SFP RJ45 100BaseT RS485 + two 100BaseFx Eth, Multimode ST + one 10/100BaseT Eth, RJ-45 ²
Software Options ¹			00										No Software Options IEC 61850 1 Phasor Measurement Units (PMU) 1 Phasor Measurement Units (PMU) + IEC 61850 2 Phasor Measurement Units (PMU) 2 Phasor Measurement Units (PMU) + IEC 61850 4 Phasor Measurement Units (PMU) 4 Phasor Measurement Units (PMU) + IEC 61850 CyberSentry UR Lvl 1 IEEE 1588 PRP IEEE 1588 + CyberSentry 6 x PMU 6 x PMU + IEC61850 IEC 61850 + PMU + 61850-90-5 IEC60870-5-103 + IEEE1588 + PRP + IEC61850 + CyberSentry UR Lvl 1 + MSOD
Mount				H	A								Horizontal (19" rack) - Standard Horizontal (19" rack) - Harsh Chemical Environment Option
User Interface					E	F							7" Graphical display, USB front port & programmable pushbuttons - Multi-Language (FW 7.6x or higher) Vertical Front Panel with English Display Enhanced German Front Panel Enhanced German Front Panel with User-Programmable Pushbuttons Enhanced English Front Panel Enhanced English Front Panel with User-Programmable Pushbuttons Enhanced French Front Panel Enhanced French Front Panel with User-Programmable Pushbuttons Enhanced Russian Front Panel Enhanced Russian Front Panel with User-Programmable Pushbuttons Enhanced Chinese Front Panel Enhanced Chinese Front Panel with User-Programmable Pushbuttons Enhanced Turkish Front Panel Enhanced Turkish Front Panel with User-Programmable Pushbuttons Enhanced Polish Front Panel ² Enhanced Polish Front Panel with User-Programmable Pushbuttons ² Enhanced Japanese Front Panel ² Enhanced Japanese Front Panel with User-Programmable Pushbuttons ²
Power Supply				H	L								125/250 V AC/DC 4 - 48 V (DC only)
CT/VT DSP	Required for PMU Option						8N	8L	8N	8L			Standard 4CT/4VT w/ enhanced diagnostics Standard 8CT w/ enhanced diagnostics
IEC 61850 Process Bus ⁴	Required for PMU Option							81					8 Port IEC 61850 Process Bus Module -9-2LE & 61869 Process Bus, 2 x 1000BaseF -9-2LE & 61869 Process Bus, 4 x 1000BaseF + 4 x 100BaseFx -9-2LE & 61869 Process Bus, 4 x 100BaseFx
Digital I/O							XX	XX	XX	XX	XX	XX	No Module 8 Form-A (No Monitoring) Outputs 2 Form-A (Voltage w/ opt Current) & 2 Form-C Outputs, 8 Digital Inputs 2 Form-A (Voltage w/ opt Current) & 4 Form-C Outputs, 4 Digital Inputs 8 Form-C Outputs 16 Digital Inputs 4 Form-C Outputs, 8 Digital Inputs 8 Fast Form-C Outputs 2 Form-A (Current w/ opt Voltage) & 2 Form-C Outputs, 8 Digital Inputs 4 Form-A (Current w/ opt Voltage) Outputs, 8 Digital Inputs 6 Form-A (Current w/ opt Voltage) Outputs, 4 Digital Inputs 2 Form-A (No Monitoring) & 2 Form-C Outputs, 8 Digital Inputs 2 Form-A (No Monitoring) & 4 Form-C Outputs, 4 Digital Inputs 4 Form-A (No Monitoring) Outputs, 8 Digital Inputs 2 Form-A (No Monitoring) Outputs, 4 Digital Inputs 2 Form-A (Cur w/ opt Volt) 1 Form-C Output, 2 Latching Outputs, 8 Digital Inputs 30 Contact Inputs - Pin Terminals ² 18 Form-A (No Monitoring) Outputs - Pin Terminals ² 16 Digital Inputs with Auto-Burnish 14 Form-A (No Monitoring) Latchable Outputs
Transducer I/O							5A	5A	5A	5A	5A	5A	4 dcmA Inputs, 4 dcmA Outputs 8 RTD Inputs 8 RTD Inputs
Inter-Relay Communications							5F	5F	5F	5F	5F	5F	2A 2A C37.94SM, 1300 nm singlemode, ELED, 1 Channel singlemode 2B 2B C37.94SM, 1300 nm singlemode, ELED, 2 Channel singlemode 2I 2I Channel 1 - IEEE C37.94, 820nm, multimode fiber, 64/128 kbps; Channel 2 - 1300 nm, singlemode, LASER 2J 2J Channel 1 - IEEE C37.94, 820nm, multimode fiber, 64/128 kbps; Channel 2 - 1550 nm, singlemode, LASER 7C 7C 1300 nm, singlemode, ELED, 1 channel 7H 7H 820 nm, multimode, LED, 2 Channels 7I 7I 1300 nm, multimode, LED, 2 Channels 7J 7J 1300 nm, singlemode, ELED, 2 Channels 7M 7M Channel 1 - RS422; Channel 2 - 1300 nm, multimode, LED 7S 7S G.703, 2 Channels 7V 7V RS422, 2 Channels, Dual ClockV 7W 7W RS422, 2 Channels, Single Clock 73 73 1550 nm, singlemode, LASER, 2 Channels 77 77 IEEE C37.94, 820 nm, multimode, LED, 2 Channel

Ordering Notes:

- To view all the options available for N60, please visit GE's On-Line Store <http://store.gedigitalenergy.com/viewprod.asp?model=N60>
- Option available soon
- Process bus module requires empty slots next to it.
- Conventional DSP and Process Bus modules cannot run simultaneously

[GEGridSolutions.com](https://www.GEGridSolutions.com)

IEC is a registered trademark of Commission Electrotechnique Internationale. IEEE is a registered trademark of the Institute of Electrical Electronics Engineers, Inc. Modbus is a registered trademark of Schneider Automation. NERC is a registered trademark of North American Electric Reliability Council. NIST is a registered trademark of the National Institute of Standards and Technology.

GE, the GE monogram, Multilin, FlexLogic, EnerVista and CyberSentry are trademarks of General Electric Company.

GE reserves the right to make changes to specifications of products described at any time without notice and without obligation to notify any person of such changes.

Copyright 2023, General Electric Company. All Rights Reserved.

GEA-12758P(EN)
English
230413

